

Varenummer: 588Q2C616SB0466
 Beskrivelse: Magnetventil type Q2C616.SB0.466 2/2 NC
 12 VDC dyse 1,6 hus i Rustfast AISI 303 Portstr. G1/4"

Mål

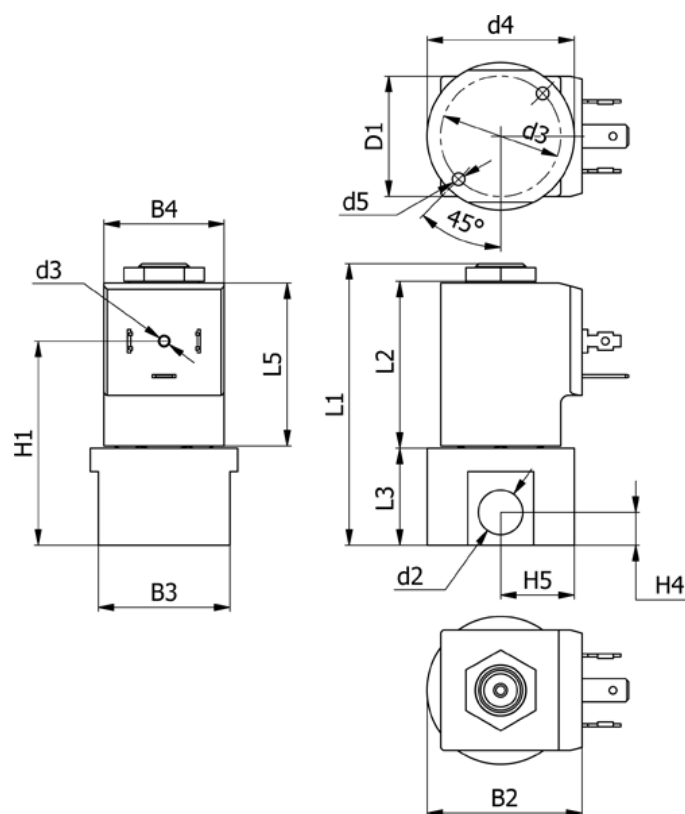

B2 = 40	H1 = 52.5	Ventilfunktion = 2/2 NC
B3 = 34	H4 = 8.5	
B4 = 31	H5 = 19	
d2 = G1/4"	L1 = 72.6	
d3 = M3x4	L3 = 25	
d4 = 31	L5 = 42.5	
d5 = M4x8	Lysning = 1.6	
Flow = 1.7	Spænding = 12 VDC	